



ENGLISH

INSTRUCTION MANUAL



PLM mono bloc



PLM

9000E-12000E-15000E
PLUS HEATER VERSIONS



CE

THANK YOU!

Thank you for choosing this innovative Amcor air conditioner. We suggest that you keep this manual in a safe place for future reference. It describes the many benefits and advanced features this unique product has to offer. Before you use your new air conditioner you should carefully read these instructions to maximise this product's performance.

For over 50 years Amcor has specialised in complete indoor environmental control, manufacturing and marketing; dehumidifiers, portable air conditioners, coolers, air purifiers, ionisers and aroma therapy scent diffusers. These world class products incorporate the latest technological developments.

ELECTRIC CONNECTION

For your safety please read the following information.

Warning: This appliance must be earthed.

The appliance is supplied with a moulded 13 amp 3 pin mains plug fitted with a 13 amp fuse. Should the fuse require replacement, it must be replaced with a fuse rated at 13 amp and approved to BS1362.

The plug contains a removable fuse cover that must be refitted when the fuse is replaced. In the event of the fuse cover being lost or damaged, the plug must not be used until a replacement cover has been obtained.

If the moulded mains plug is unsuitable for the socket outlet in your home or is removed for any other reason, then the fuse should be removed and the cut off plug disposed of safely to prevent the hazard of electric shock.

There is a danger of electric shock if the cut off plug is inserted into any 13 amp socket outlet.

Important

The wires in the mains lead on this appliance are coloured in accordance with the following code:

Green and Yellow - Earth

Blue - Neutral

Brown - Live

As the colours may not correspond with the markings identifying the terminals in your plug proceed as follows.

The green and yellow wire must be connected to the terminal in the plug which is marked with the letter E or with the earth symbol \perp or coloured green and yellow.

The blue wire must be connected to the terminal marked N or coloured black.

The brown wire must be connected to the terminal marked L or coloured red.

How to wire a 13 amp plug.

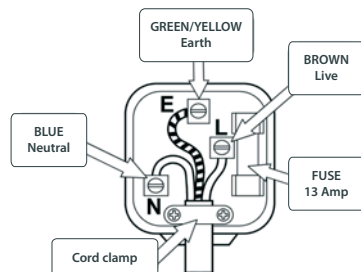



IMPORTANT

- The unit is designed for indoor operation.
- Rating: This unit must be connected to a 220-240 V / 50 Hz earthed outlet.
- The installation must be in accordance with regulations of the country where the unit is used.

If you are in any doubt about the electrical installation, have it checked and if necessary modified by a qualified electrician.

- The air conditioner is safe. However, as with other electrical appliances, use it with care.
- Keep out of the reach of children.
- Do not clean the air conditioner by spraying it or immersing it in water.
- Do not insert any object into the opening of the air conditioner.
- Disconnect it from the mains before cleaning the unit or any of its components.
- Never connect the unit to an electrical outlet using an extension cord. If an outlet is not available, one should be installed by a licensed electrician.
- Any service other than regular cleaning or filter replacement should be performed by an authorized service representative. Failure to do so could result in a loss of warranty
- A damaged supply cord should be replaced by the manufacturer, its service agent or a qualified person in order to avoid a hazard.

WARNING

- Never operate this appliance if it has a damaged cord or plug. Do not lead the cord over sharp edges.
- Don't lift or move by pushing the air conditioner at the rear, but always at the front side.

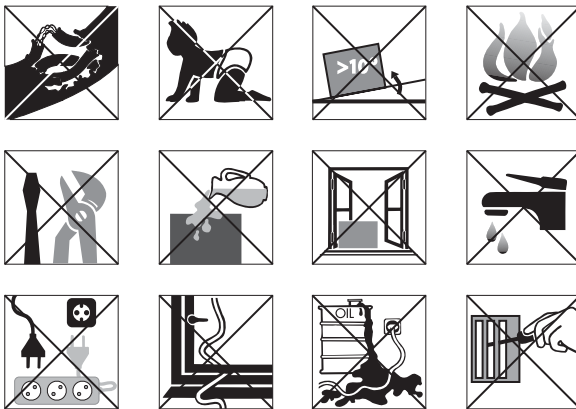

PARTS

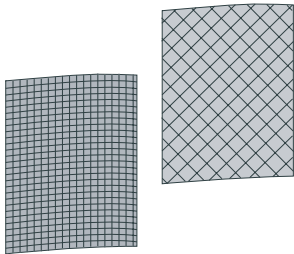
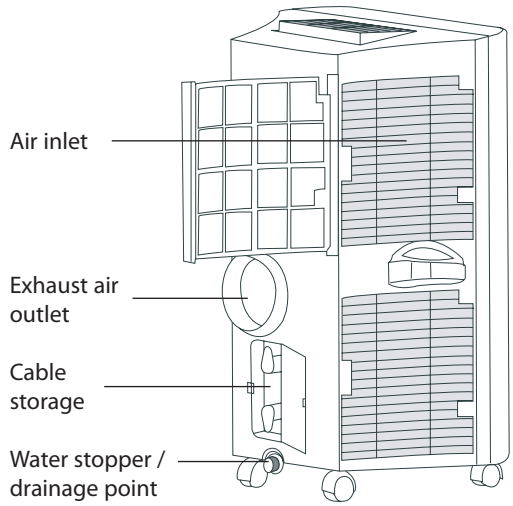
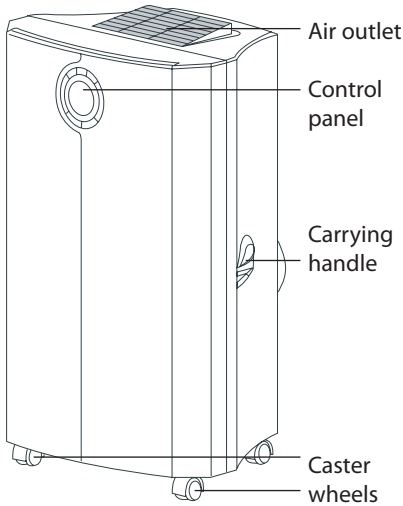

Air filter

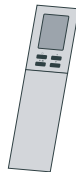

Remote control

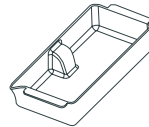

Water container

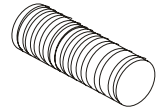

Exhaust hose



Slide bar connector

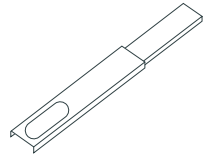

Telescopic slide bar

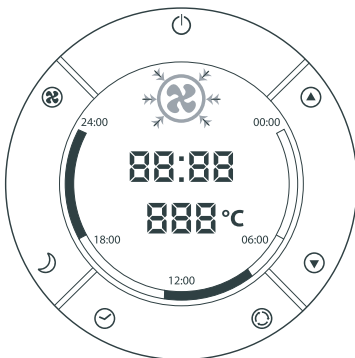

Controls

- ON/OFF
- UP
- DOWN
- MODE
- TIMER
- SLEEP
- FAN SPEED

Display

- COOLING
- FAN
- HEAT
- 88:88 HOURS:MINUTES
- 888 TEMPERATURE

INSTALLATION

WARNING! Before using the air conditioner it should be left in an upright position for at least 2 hours.

This unit can easily be moved from one room to another. In doing so keep this in mind:

- Ensure that the unit is positioned upright, on a level surface and 50 cm away from obstacles.
- To place the loose filters in the filter holder.
 - Take the filter holder out of the air conditioner
 - Open the filter holder and place the active carbon filter (black) and 3M Filtrete™ filter (white), where included, in the filter holder.
 - Place the filter fixing component back in the holder.
 - Place the filter holder back in the air conditioner.
- Do not operate the unit inside the bathroom, shower, or in any other very humid environment.
- Connect the hose to the unit by turning it clockwise (at least 5 turns).
- Similarly, connect the hose to the slide bar connector as far as possible.
- Place the telescopic slide bar in the open window or door and adjust the length to fill as much open space as possible.
- Put the slide bar connector in the opening in the telescopic slide bar.
- Close the window or door as much as possible to prevent outside air entering the room.
- Ensure that the slide bar connector has a free flow outside.

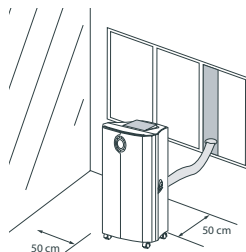

Important







The flexible exhaust hose can be extended from 500 to 1500 mm for mounting. This length has been designed especially according to the specifications of the air conditioner. Do not use an extension or exchange for a different hose as that may lead to malfunctioning. The exhaust air must flow freely, any blockage can lead to overheating of the air conditioner. Take care to prevent any sharp bow or bend in the exhaust.

OPERATION

ON/OFF

Press  to switch the unit on or off. A buzzer will beep, and the LCD will display 12:00 o'clock as default.

Setting the clock

Press the  button for 3 seconds to set the clock. The 2 left digits of the 4 digits on the LCD-display will flash. Press  or  to adjust the hour. Press  momentarily, the 2 right digits of the 4 digits will flash. Press  or  to adjust the minutes of the clock. Press the  button for 3 seconds again to activate the clock.

Setting the temperature

If you want to change the set temperature press ▲ or ▼ to set the temperature. The 2 digit display will indicate the set temperature.

Note: Reaching the set temperature depends on the room and outdoor climatic conditions.

Mode switch

Press the ⏻ button successively until the icon representing the desired mode is appearing (=> Cool => Fan => Heat => etc). On the LCD-display you will see:

Cooling ❄️ Fan only 🌀 Heat ☀️

Each time the unit starts, it starts operating in cool mode with a set temperature of 22°C. The fan speed will be selected automatically. Heat mode is only available on EH models.

Fan speed

If you prefer a constant fan speed instead of the auto fan speed, press the 🌀 button successively; the fan icon 🌀 on the LCD-display will rotate accordingly.

- Fast - for the turbo speed
- Normal - for the medium speed
- Slow - for the slow speed
- Alternating - for the auto fan speed (in the cooling mode only!)

Heat

EH models feature a 1650 W electric heater that can heat a room on cooler days. With the mode switch select ☀️, set the desired temperature and the unit will heat until this temperature is reached. Fan speed is selected automatically. Do not place the unit near anything that could catch fire or be scorched. Do not obstruct the air outlet. The heat function will operate with or without the hose attached.

Timer

For all of the following TIMER programming, proceed firstly with these standard steps:

- Press the ⏻ button briefly; the 2 left digits of the 4 digits on the LCD display are flashing.
- Press ▲ or ▼ to adjust the hour.
- Press the ⏻ button briefly again, the 2 right digits of the 4 digits are flashing.
- Press ▲ or ▼ to adjust the minutes of the clock in intervals of 5 minutes. The timer is set. After 10 seconds the time display returns.

Programming the timer for ON - when the unit is OFF.

- Perform the standard steps as described above.

The circular time scale will be on between the ON programmed times until 24:00. The flashing bar on the time scale indicates the real time and moves a segment ahead every 30 minutes until it reaches the ON timer time, then the black segments in the circular time scale will disappear.

Programming the timer for OFF - when the unit is RUNNING.

- Perform the standard steps as described above.

The circular time scale will be on between the present time to the OFF programmed time. The flashing bar on the time scale indicates the real time and moves a segment ahead every 30 minutes until it reaches the OFF timer time, then the black segments in the circular time scale will disappear.

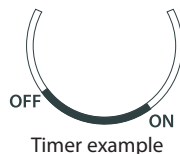

Repeat OFF and ON

Programming the timer for repeat OFF and ON - when the unit is RUNNING.

- Perform the standard steps as described above.
- Repeat the above procedure while the digits are still flashing for setting the ON.

The circular time scale will be ON between 00:00 to the time set with the timer to OFF and from that time until 24:00. The flashing bar on the time scale indicates the real time and moves a segment ahead every 30 minutes. The unit will operate daily according to the timer setting.

Repeat ON and OFF

Programming the timer for repeat ON and OFF - when the unit is NOT RUNNING.

- Perform the standard steps as described above.
- Repeat the above procedure while the digits are still flashing for setting the OFF.

The circular time scale will be OFF between 00:00 to the time set with the timer to ON and from that time until 24:00. The flashing bar on the time scale indicates the real time and moves a segment ahead every 30 minutes. The unit will operate daily according to the timer setting.

After a power failure, or after the unit has been unplugged, you will have to program the timer settings again.

Cancelling the timer function

In order to cancel the timer programming press the ☺ button momentarily, then it will return to the time display. The daily mode will be cancelled as well. The black segments in the circular time scale will disappear.

Air flow

Direct the air flow by adjusting the grill on top of the air conditioner. Move the grill, by pushing or pulling, in the middle (see illustration). This will avoid uneven positioning of the grill. Adjusting the air flow is as also possible by moving the direction of the vertical louvres.



Sleep mode

The sleep mode function adjusts the set temperature of the unit to the thermal needs of the body falling asleep as follow:

- In the COOL or AUTO COOL mode
- Default fan speed: LOW
- Press the ☾ button to operate the sleep mode. Press the ☽ button again in order to cancel the sleep mode.

The set temperature will increase 1°C after 1 hour and a further 1°C after 2 hours.

- No FAN mode under SLEEP mode operation

Dehumidification

If the unit will be used mainly as a dehumidifier just let the warm air return in the room. Continuous drainage is then necessary and more efficient.

For continuous drainage:

- Switch off the unit and remove the plug from the mains.
- Remove the water stopper and rubber plug.
- Connect a drain tube (ø 20 mm inner dimension) onto the water outlet and extend with extra water tube if needed.
- Place the other end in a normal drain. Make sure that the tube is free from twists and bends. The tube must decline over its entire length.

AIR FILTER

This air conditioner can be equipped with a 3-layer filter to clean the circulated room air.

- a. Screen filter; to remove bigger dust particles.
- b. All models: active carbon filter; to remove odours.
- c. 3M Filtrete™ filter; to remove unhealthy particles from the air such as pollen, bacteria, animal dander and dust. Selected models have the 3M Filtrete™ filter as standard.
However, if you require to add this to your model, or wish to purchase a replacement, call Amcor for details.

NOTE! The active carbon filter and the 3M Filtrete™ filter are delivered in a plastic packaging. Don't forget to install these filters. These filters take away unhealthy particles out of the room environment.

The filter frame on the rear of the unit can be opened. The active carbon filter and 3M Filtrete™ filter can be installed or removed. The screen filter is part of the filter frame (see illustration).

- a. The screen filter has to be cleaned regularly with a vacuum cleaner to avoid blocking of the air flow.
- b. The positive/negative electrostatically charged 3M Filtrete™ filter is recommended to be changed every 3 months. Unusual dirt, construction work, pets, the presence of smoke and running the air conditioning unit continuously can shorten the life time of the 3M Filtrete™ filter.
- c. The active carbon filter can be cleaned with a vacuum cleaner when dusty but has to be changed at the same time as the 3M Filtrete™ filter.

Filter installation

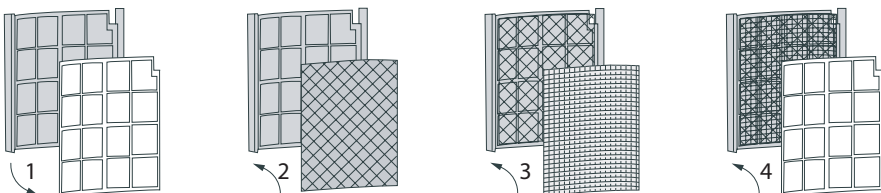

- Slide out the filter frame from the unit.
- Separate the filter fixer from the filter frame (see fig. 1).
- Remove the active carbon filter (black) and the 3M Filtrete™ filter (white) from its plastic bag.
- Insert the active carbon filter into the filter frame (see fig. 2).
- Insert the 3M Filtrete™ filter into the filter frame (see fig. 3).
- Fix the filter by reassembling the fixer into the filter frame (see fig. 4).

NOTE!

- Remove the 3M Filtrete™ filter and active carbon filter before seasonal storage and install new filters at the beginning of the new season. The old filters can be disposed in the 'Non-biological garbage container'.
- Replacement filter packages are available directly from Amcor.
- To run the unit without active carbon filter and/or 3M Filtrete™ filter does not do any harm to the air conditioner. In this case odours and unhealthy dust are not removed from the circulated air.
- **The screen filter must always be used.**

REMOTE CONTROL

The unit responds to all signals that are sent by the remote control. There will be a beep sound from the unit after receiving the signal.

The operation of the unit by remote control, is almost identical to the operation by the circular control panel. The only exception is the clock function.

Instead of the ⌚ button for setting the actual time and for programming the timer, there are 3 push buttons on the remote control as follows:

- ⌚ - for setting the actual time.
- TIMER ON - for programming the time when the unit is ON.
- TIMER OFF - for programming the time when the unit is OFF.



EMPTYING THE INTERNAL WATER CONTAINER

Under high humidity conditions it may be necessary to empty the internal water container. When the internal water container is full the backlight on the LCD-display flashes. The unit will switch off automatically.

To empty the water container do the following:

- Switch off the unit and remove the plug from the wall socket.
Do not move the unit. Doing this can result in water leakage, damaging your floor or carpet.
- Place the water container on the floor underneath the permanent drainage point.
- Remove the water stopper and rubber plug from the drain and let the water run out. The water container has to be emptied several times before all water will be drained (ca. 1.5 litres).
- Replace the rubber plug and water stopper, put the plug into the wall socket, and switch the unit on.

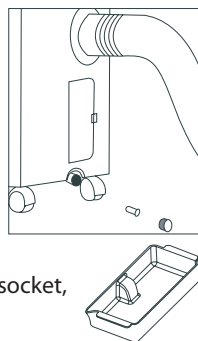

The warning signal should be off.

NOTE! When the air conditioner is in use, under normal circumstances the condensed water will evaporate and then be discharged through the hot air outlet hose

CLEANING

WARNING! First of all switch off the unit and remove the plug from the wall socket.

Clean the housing with a soft, damp cloth. Never use aggressive chemicals, petrol, detergents or other cleansing solutions.

Clean the screen filter regularly with a vacuum cleaner. See also “air filter” section.

NOTE! Never use the air conditioner without the screen filter.

TROUBLE SHOOTING

Never try to repair or dismantle the air condition yourself. Incompetent repairs result in loss of warranty and can endanger the user and the property.

Problem	Cause	Solution
The air conditioner does not function.	No power supply.	Connect to a functioning outlet and switch on.
	Is the LCD light flashing.	Empty the internal water container.
	Timer function is active.	Deactivate TIMER function.
The air conditioner does not seem to perform.	In direct sunlight.	Close curtains.
	Windows or doors open, many people or a heat source in the room.	Close doors and windows, place an extra air conditioner.
	Dirty filter.	Clean or replace the filter(s).
	Air inlet or air outlet blocked.	Remove the blockage.
	Room temperature lower than the selected value.	Change temperature selection.
The unit is noisy.	Unit stands uneven.	Place on an even, solid surface (less vibrations).
The compressor does not work.	The overheat protection is probably activated.	Wait 3 minutes until the temperature has decreased, then turn on the unit again.
The remote control does not function.	Distance too great.	Make sure the remote control is correctly aimed at the control panel.
	Remote control signal not detected by the control panel.	
	The batteries are drained.	Replace the batteries.
To correct problems that have not been described in the table and/or if the recommended solutions fail to solve the problem, contact an authorized service centre.		

STORAGE

Empty the internal water container.

Clean the screen filter.

Remove 3M Filtrete™ filter and active carbon filter.

- Remove the 3M Filtrete™ filter and active carbon filter before end of season storage and install new filters at the beginning of the new season.

The old filters can be disposed of in the 'Non-biological rubbish container'.

- Replacement filter packages are available from Amcor.

Put the unit in Fan Only mode for a few hours to ensure that the inside becomes completely dry.

Store the cable as shown.

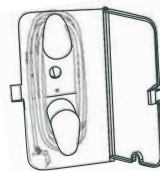

Protect the unit against dust and store in a dry place, not accessible to children.

TECHNICAL DATA

Model		9000E	12000E	15000E
Cooling capacity *	BTU/h	7000	9000	12000
	kW	2	2,6	3,5
EE Class*		A		
EER*		2,8		
Power consumption	W	880	1100	1330
Current	A	4	5	6
Mains	V / Hz / PH	220 - 240 / 50 / 1		
Air delivery max.	m ³ /h	450		
Dehumidification max.**	L/24h	20		
For rooms up to	m ²	75		
Compressor model		rotary		
Fan speeds		3 (2+1 turbo)		
Thermostatic range	°C	18 - 32		
Noise level	dB	49		
Protection class		IP 21		
Refrigerant charge	type / g	R407C / 480		
Dimensions (w x h x d)	mm	555 x 800 x 455		
Net weight	kg	31,5	34	39
* measured conform EN 14511.		** moisture removal at 32°C, 80% RH.		
Subject to modifications without prior notice. For greater precision, please refer to the rating label placed on the product.				



Reminder:

Waste electrical products must not be disposed of with household waste.

This product should be taken to your local recycling centre for safe treatment.

Hong Kong

Amcor Ltd
Suite 2007, Tower 6, The Gateway,
Harbour City, 9 Canton Road,
Tsim Sha Tsui, Kowloon,
Hong Kong
Tel: +852 2997 6865
Fax: +852 2997 6091
Email: amcorhk@amcorgroup.com

United Kingdom

Amcor Ltd
9 Ryan Drive, West Cross Centre,
Great West Road, Brentford,
Middlesex, TW8 9ER,
United Kingdom
Tel: +44 20 8560 4141
Fax: +44 20 8232 8814
Email: amcoruk@amcorgroup.com

USA

Amcor Inc.
685A Gotham Parkway, Carlstadt,
New Jersey 07072,
United States of America
Tel: +1 201 460 8100
Fax: +1 201 460 9481
Email: amcorusa@amcorgroup.com

The Netherlands

Amcor B.V.
Anton Philipsweg 9-11,
1422 AL Uithoorn,
The Netherlands
Tel: +31 297 560 079
Fax: +31 297 523 062
Email: amcorex@amcorgroup.com

Israel

Amcor International Ltd
1 Sapir St.,
P.O. Box 12001
Hertzeliya Pituach,
Israel
Tel: +972 9951 5351
Fax: +972 9958 5650
Email: amcoril@amcorgroup.com

Singapore

Amcor Investments (Singapore) Pte Ltd
545 Orchard Road,
#13-02, Far East Shopping Centre,
Singapore 238882
Tel: +65 6297 9881
Fax: +65 6297 8891
Email: amcorsg@amcorgroup.com

China

Shan Xia Industrial Development Zone,
Heng Li Town, Dongguan City,
Guangdong Province, China

Plant One - Amcor (China) Ltd

Tel: +86 769 8372 1090
Fax: +86 769 8372 1790
Email: amcorcn@amcorgroup.com

Plant Two - Amcor Appliances Ltd

Tel: +86 769 8372 1970
Fax: +86 769 8372 1790
Email: amcorappl@amcorgroup.com

